



RAMRODS

PRODUCT GUIDE
SPRING 2026

MEET THE RAMRODS TEAM



Joe Fanchin
Product Director



Josh Smith
Operations Director



Maddie Braun
Creative Director



Douglas Denton
Product Engineer



Marlene G.
Pro-Staff Manager



Lauren W.
Graphic Designer



Barney L.
Shop Manager



Andres F.
Shop Staff



Abigail L.
Shop Staff



Tyler P.
Shop Staff

As a company founded and run by archers, we make the products that we wish we could have had when we were shooting and provide them to today's athletes. Our design philosophy is to create products that solve archers problems, help them improve faster, and support them in becoming the best archer they can be. Whether your dream is setting a new personal record at a local event or making it to the highest level of international competition, RamRods is here to partner with you on that journey.

If you see us on the shooting line, go easy on us!

TERMS AND TECH



C-SPINE

Mysteries of the C-SPINE

Cantilever Spine or C-Spine is a measure of how much a stabilizer flexes under load. We measure C-Spine by locking down one end of a 30 inch stabilizer and hanging 5 lbs of weight from the other side. That deflection is the C-Spine of the stabilizer. A higher C-Spine indicates a weaker stabilizer and lower C-Spine indicates a stiffer stabilizer. This lets us compare one stabilizer to another and pair any archer with the perfect rod for them.



WIND TAPER

Benefits of the WIND TAPER

The RamRods Wind Taper provides you with three key benefits. First, it makes the tip of your stabilizer more wind efficient by reducing wind drag. Second, it makes the base of your stabilizer stiffer and more stable where it experiences the most stress. Third, it reduces more vibration from your shot by channeling vibration away from the bow and towards the tip of your stabilizer.

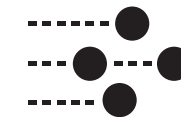

VIBRO CORE

VIBRO-CORE and How it Works

VIBRO-Core comes standard in every RamRods stabilizer. This rubber-based particle damping system provides you with vibration damping inside your stabilizer. By removing excess noise and vibration from your shot, VIBRO-Core allows you to more accurately feel what is happening in your shot and improve faster.

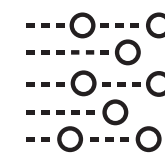

TUNGSTEN

TUNGSTEN and Why We Love it

Our patented tungsten damping technology incorporates micro tungsten particles as an optional addition in the tip of your stabilizer or in one of our tungsten damping cases. When you shoot, these particles rapidly move around and absorb harmful vibration. This provides you with a uniquely satisfying shot experience you can't find anywhere else.



ZERO BACKLASH

What's the Deal with ZERO BACKLASH

Backlash refers to the gaps in gear teeth that create slipping issues. If the space is too large, it can cause one gear to turn without engaging the other. This is a common sight issue, where a microadjustment of one or two clicks up or down might not actually be moving anything. A sight engineered to ensure zero backlash guarantees that each twist of an adjustment knob will move the aperture as intended.

SPECTRA

RECURVE SIGHT

At RamRods, we are obsessed with helping archers shoot better scores. So when it came to engineering our sight, we left no surface untouched and optimized every detail. We've eliminated backlash, made it reversible, and gave it looks that stand out on the shooting line.

We even brought in all the features you've come to love from our stabilizers, like aerodynamic geometry, internal damping, aerospace grade materials, and uncompromising quality standards.

Available in silver, red, blue, and black.
SPECTRA Compound Sight coming soon...

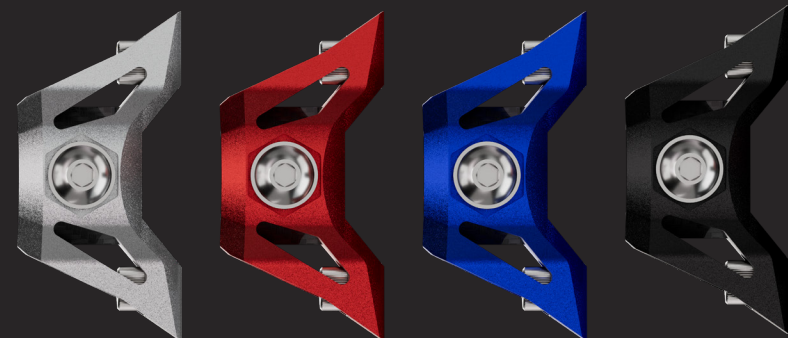
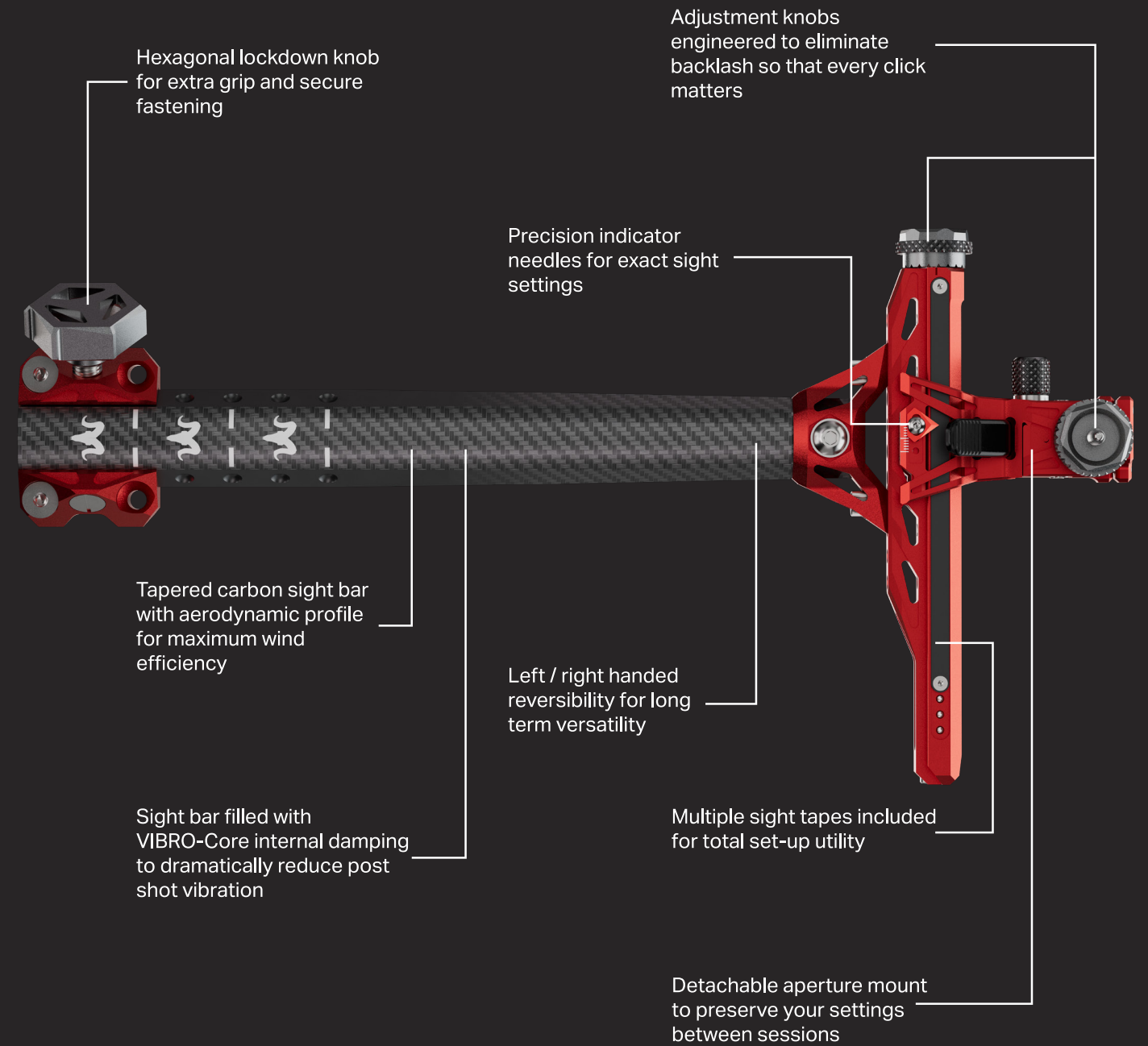
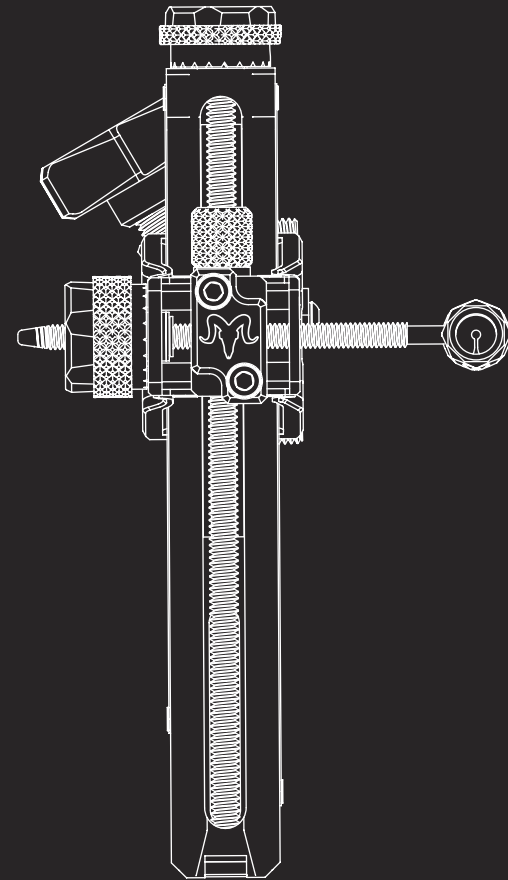
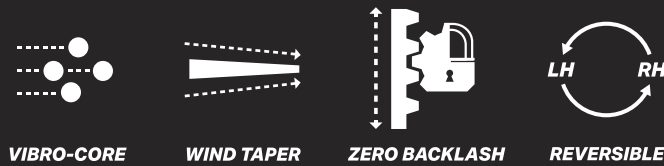

SEE WHERE YOUR JOURNEY LEADS...



VEKTOR²

BRADY ELLISON

5 x OLYMPIAN

Long Rod | 30"

Side Rods | 12"

Adjustable V-Bar

EDGE 1 inch Eyebolt

EQ Cylinder Damper

Stainless Steel Weights





VEKTOR²

VEKTOR 2

The Vektor 2 follows up the extremely popular Vektor, our first tapered stabilizer. We updated the profile to be slightly less tapered than the original Vektor, and the tip is now 0.53 inches and the base is at 0.60 inches. The result is a stabilizer that provides the same average diameter (and wind efficiency) as the Vektor but with an improved feel and vibration reduction, especially on compound bows. The Vektor 2 significantly reduces limb tip flutter and delivers a consistent shot reaction. If you were a fan of the original Vektor, you're going to love this new version even more.

Lengths (in inches): 10, 11, 12, 13, 14, 15, 26, 27, 28, 29, 30, 32

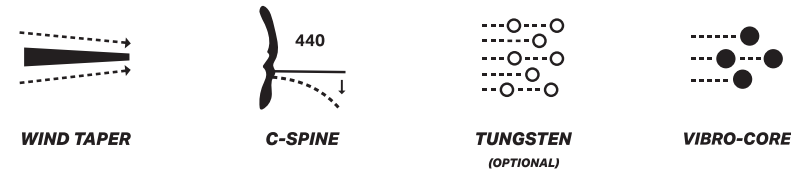

TYPES

The Vektor 2 Type S takes stiffness to the next level. This is a stiffer version of the Vektor 2, so it's meant for the archer that still needs the tapered, wind efficient build but wants to have a bit more mass weight. It can comfortably support up to 30 ounces at the end of the stabilizer.

Lengths (in inches): 26, 27, 28, 29, 30, 32

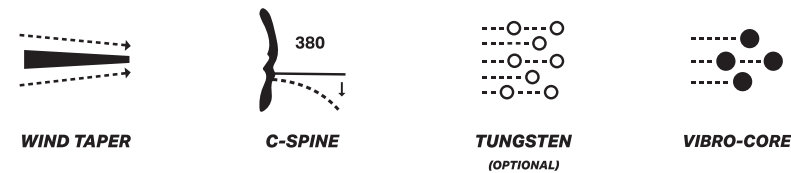

ULTRA V4

ULTRA 4

The Ultra 4 is the recurve stabilizer of the future. With a tip diameter of only 0.44 inches, this stabilizer keeps you at your best even in windy conditions. With multiple internal damping options and enough stiffness to support up to 12 ounces on the front rod, the Ultra 4 provides recurve shooters with a next level shot response that can't be found anywhere else.

Lengths (in inches): 10, 11, 12, 13.5, 15, 26, 27, 28, 29, 30, 33

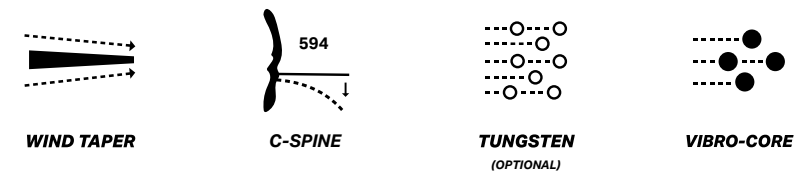

TYPES

The Ultra 4 S is for the extreme archer-- definitely not for everyone. It is a ~10% stiffer version of the Ultra 4 and uses a unique carbon layup providing enhanced aiming and vibration reduction. It can comfortably support up to 16 ounces out at the end while maintaining that super thin, wind efficient build.

Lengths (in inches): 26, 27, 28, 29, 30, 33

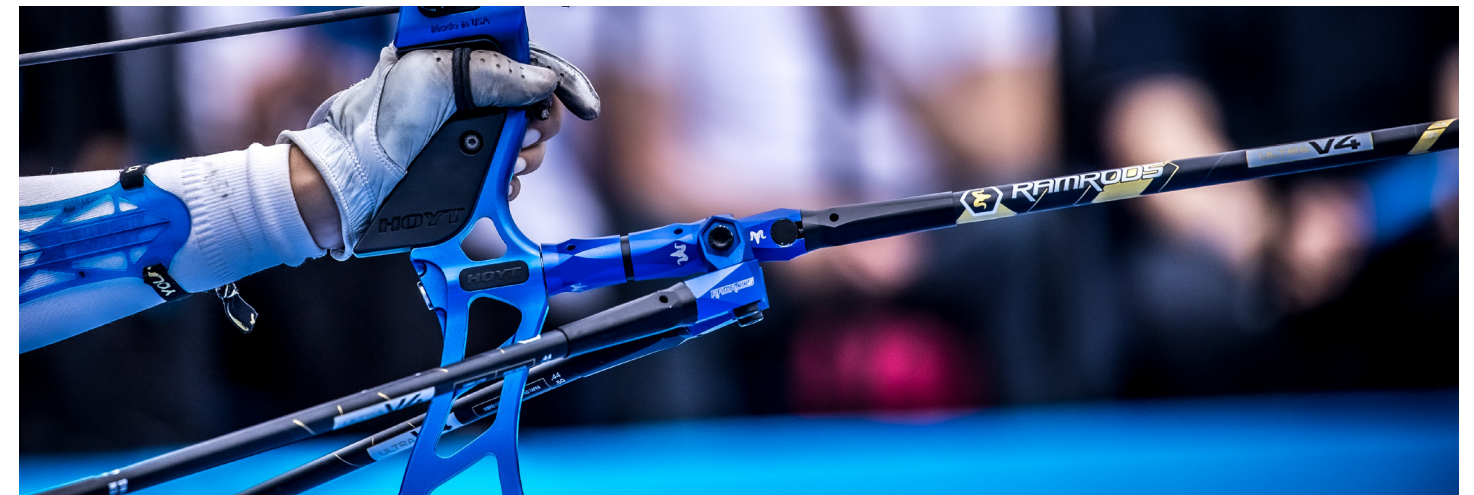
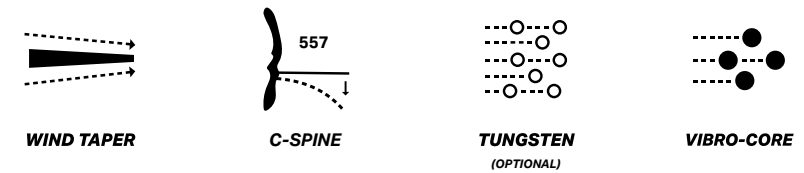



ULTRA **V4**

ANDRÉS TEMIÑO MEDIEL
2025 WORLD CHAMPION

Long Rod | Type S | Tungsten Damping | 30"
Side Rods | Tungsten Damping | 15"





BEAST

BEAST

The Beast is the stabilizer of choice for compound athletes at the top of their game. The taper geometry keeps it wind efficient while also damping vibration. If you are a compound archer looking for the ultimate stability at high mass weights then the Beast is for you.

Lengths (in inches): 10, 12, 13.5, 15, 27, 30, 33



WIND TAPER

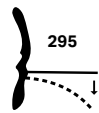

C-SPINE



TUNGSTEN
(OPTIONAL)

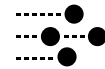

VIBRO-CORE



K2 v2

K2 2

The K2 2 will provide outstanding performance at the best possible value in its class. Featuring parallel rod geometry and excellent wind efficiency, this intermediate rod performs best with 1-14 ounces on the front rod.

Lengths (in inches): 12, 13.5, 15, 27, 30, 33

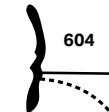

C-SPINE

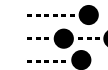

VIBRO-CORE



XP

XP

The ultimate choice for up-and-coming athletes looking to level up their game. The XP provides exceptional performance at an approachable price point and is optimized for a weight capacity of 1-10 ounces, which gives new and intermediate athletes all the versatility they need.

Lengths (in inches): 10, 12, 15, 25, 27, 30

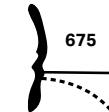

C-SPINE

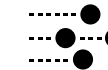

VIBRO-CORE





BEAST

ADRIANA CASTILLO

WORLD MEDALIST

Long Rod | Tungsten Damping | 33"

Side Rod | Tungsten Damping | 15"

EDGE Offset Mount

EDGE Large QDC 10°

Stainless Steel Weights

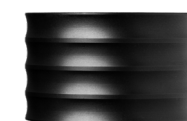



V-BARS

EDGE ADJUSTABLE V-BAR

The EDGE Adjustable V-Bar is a rock solid mounting platform - perfect for the recurve archer that wants the freedom to make changes whenever they need to.

Connection: Quick Disconnect or Screw - In

EDGE OFFSET MOUNT

The EDGE Adjustable Offset Mount features an alignment system that ensures perfect straightness of the down angle of your front rod and the interior cone lock design can handle any mass weight that a compound archer throws at it.

Connection: Quick Disconnect or Screw - In

Quick Disconnect (Barrel Nut Included)

The quick disconnect is the ultimate time saver when it comes to taking down your set up. Imagine what you could do with those few extra seconds.

Screw - In

Keep it simple with the Screw-In connection. It offers long term security when it comes to attaching your side rods.

EDGE FIXED V-BAR

The EDGE Fixed V-Bar is the no-nonsense accessory. If you already know what you want, this lightweight V-Bar is simple, secure, and features an alignment system for your QDC.

Angles: 45° x 0°, 40° x 0°, 40° x 5°, 40° x 15°



QUICK DISCONNECT

Quick Disconnects are a durable locking system that firmly mounts your stabilizers while providing quick and easy installation and removal. They are made from aerospace grade aluminum and anodized with a satin black finish to match your whole stabilizer system.

EDGE SMALL QDC

The EDGE Small QDC seamlessly blends with the Ultra 4, Vektor 2, and other EDGE accessories.

Angles: 0°, 8°, 10° degrees down

EDGE LARGE QDC

Perfectly match your EDGE Large QDC with the Beast and other EDGE accessories.

Angles: 0°, 8°, 10° degrees down

CLASSIC QDC

The Classic QDC features a flawless fit with the Vektor, K2 2, and XP.

Angles: 0°, 8°, 10° degrees down



EXTENSIONS

BIG STACK EXTENSION

The Big Stack Extension is made from aerospace grade aluminum and is extremely stiff, while providing superb performance and reliability. Discover the perfect length for you with this modular 1 inch extension.

Quantity: 1 pack or 3 pack

ALUMINUM EXTENSION 2

The Aluminum Extension 2 provides the ultimate reliability and consistency for competitive archers. It is precisely crafted from aerospace grade aluminum, with an aerodynamic aesthetic to seamlessly blend with the Vektor, K2 2, and XP stabilizers lines.

Lengths: 1 in, 2 in, 3 in, 4 in, 5 in

EDGE ALUMINUM EXTENSION

The EDGE Aluminum Extension provides lightweight reliability and consistency for competitive archers. It is intricately machined from aerospace grade aluminum with a unique geometric aesthetic that pairs perfectly with the EDGE suite of stabilizers and accessories.

Lengths: 1 in, 2 in, 3 in, 4 in, 5 in

EDGE CARBON EXTENSION

The EDGE Carbon extension is tough, lightweight, and actually dampens vibration. Filled with VIBRO-Core internal damping technology, these extensions maximize vibration absorption when paired with RamRods stabilizers.

Lengths: 3 in, 4 in, 5 in



DAMPERS

The wide variety of offerings in the EQ Damper line will provide you with an array of different damping characteristics. Some models also come in several different stiffnesses so you can really fine tune the feel and sound of your set up.

EQ BARREL DAMPER 1 INCH

The EQ Barrel is our most versatile damper. It works great in between the stabilizer and weights or splitting your weight stack. Suitable for recurve or compound, using heavy or light mass weight.

Available in 40 or 50 Stiffness

EQ CYLINDER DAMPER

The ultimate incognito vibration damper. Seamlessly blends in with your 1.25 inch weights to stay stealthy in style.

Available in 30, 40, or 50 Stiffness

EQ TAPER DAMPER 1.25 INCH

The EQ Taper Damper blends the end cap of your stabilizers to your weights. The large face is 1.25 inches and will match perfectly with our stainless steel and tungsten damping weights.

Available in 40 Stiffness

EQ BOW DAMPER

The EQ Bow Damper is tiny but mighty. It's made to screw directly onto your riser, in any of the 5/16-24 mounting holes.

Available in 30 Stiffness





VEKTOR

ANDREA MUÑOZ SAIZ
WORLD CUP MEDALIST

Long Rod | Tungsten Damping | 27"

Side Rod | Tungsten Damping | 12"

EDGE Offset Mount

EDGE Large QDC 8°

Stainless Steel Weights

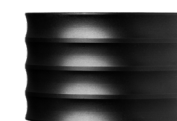

SNAG THE HUNTING SET UP

- WRAITH Stabilizer

The Wraith is designed as a hybrid stabilizer for hunters, field shooters, and 3D competitors. If you want one stabilizer that you can take from the field course to the backcountry, this is the bar for you.

Lengths (in inches): 6, 8, 10, 12, 15

- EDGE Offset Mount

- 4 inch OD Disc Weight



WEIGHTS

STAINLESS STEEL

With so many packs and stacks to choose from, the stainless steel weights offer versatility and customization to any archer. Find the perfect balance for your set up. Just one ounce can make all the difference!

Options: 2 oz Cap Weight, 1 oz 3 pack, Blender 1 oz 3 pack, 2 oz, 4 oz, 4-2-1 pack, 4 oz 5 pack, 0.5 oz 3 pack

TUNGSTEN DAMPING

Using patented vibration reduction technology, this 4 ounce weight rapidly dissipates harmful, high-frequency vibrations anywhere you use it.

BAREBOW SHIELD WEIGHT

The 12 ounce Barebow Shield Weight offers barebow shooters a modular mounting platform to control the center of gravity and total mass weight of their bow. It features eight different weight mounting locations and can easily hold up to 32 ounces of steel weights (44 ounces including the base weight).

BAREBOW HEX WEIGHT

With control over total mass, vertical position, and left-right balance, the HEX Weight lets you build a setup that matches your preferences and shooting style. The base weight is 20 ounces and contains our patented tungsten damping system. It includes 6 removable plates that are 3.3 ounces each, so you can adjust it from 20 to 40 ounces!



Shield Weight



Hex Weight



MATT YACCA
WORLD MEDALIST

Barebow Hex Weight
Tungsten Damping Weights

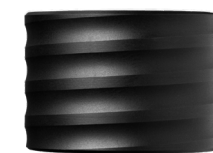
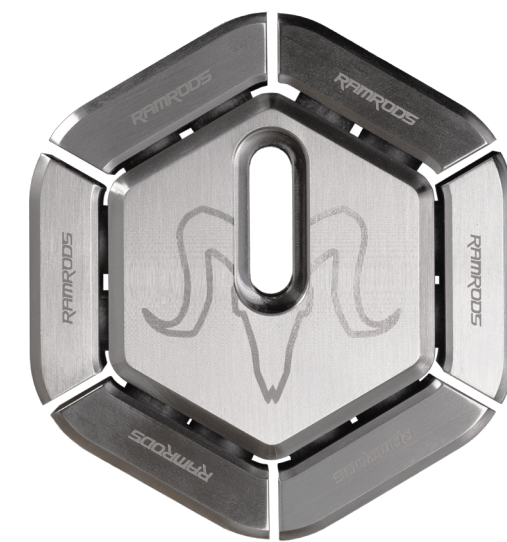

APPAREL AND ACCESSORIES



Performance Snapback - White



Performance Snapback - Black



Performance Snapback - Navy



Reversible Bucket Hat



Trucker Hat



Dad Hat



Baseball Cap



Visor



Archery Tee



Archery DDB Tee



Stabilizer Sleeves - 40 inch & 22 inch

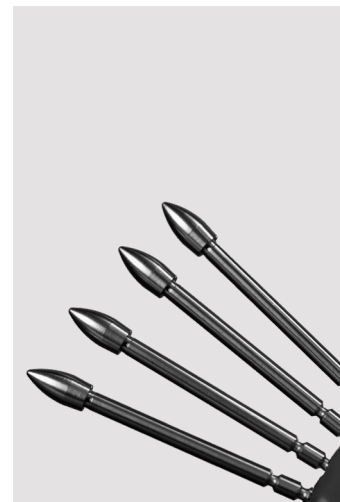

Tungsten Points for X10s - 120-110-100 & 140-130-120

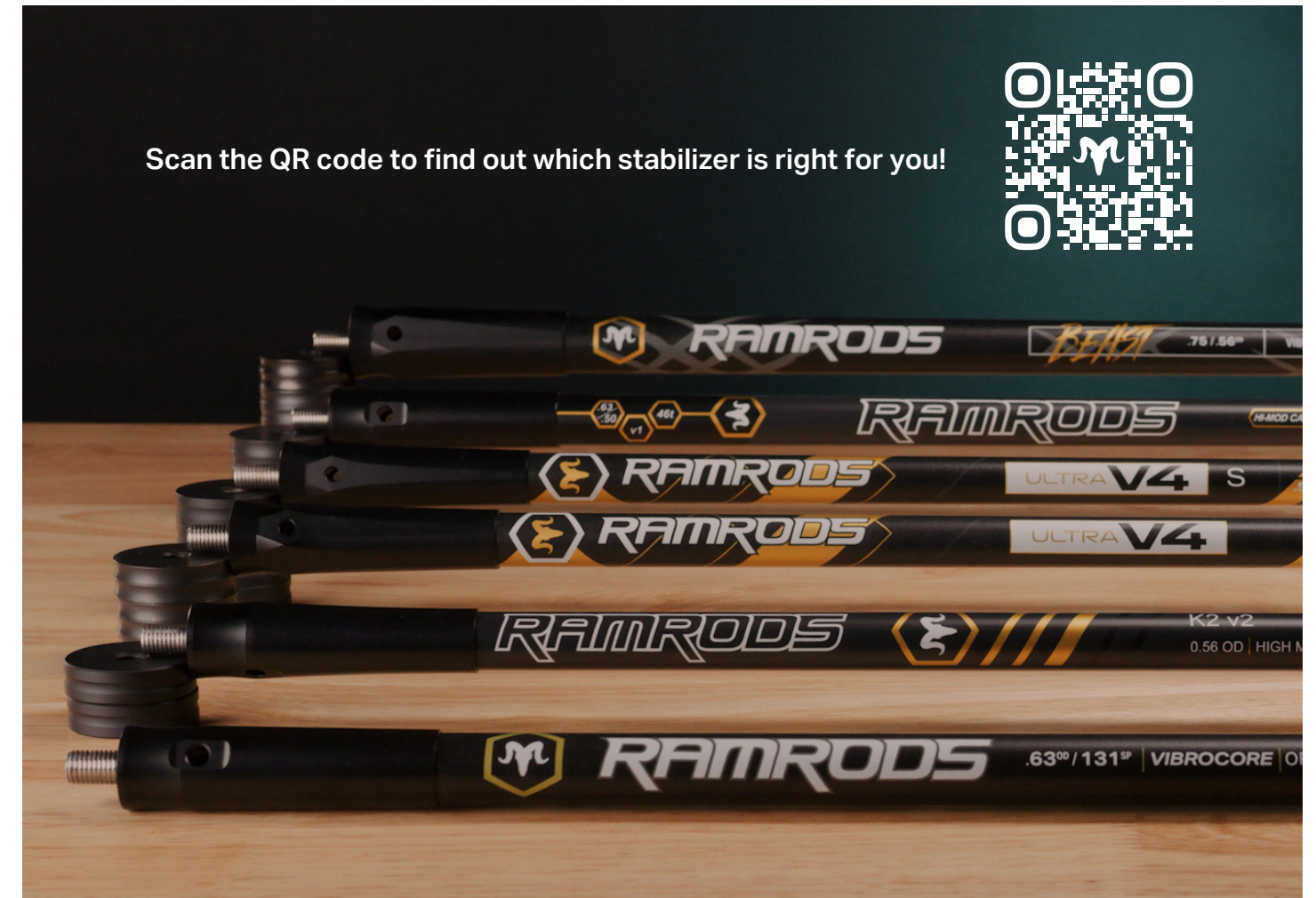

CONNECT WITH US

  @ramrodsarchery

  RamRods Archery

Visit us at www.ramrodsarchery.com

Interested in joining the team?
Pro-Staff applications open September 1, 2026!

